

Introduction

Thank you for purchasing this SHARP product. To obtain the best performance from this product, please read this manual carefully. It will guide you in operating your SHARP product.

Accessories

The following accessories are included.

 <p>Remote control x 1 (RRMCGA343AW01)</p>	 <p>NFC tag x 2</p>	 <p>Velcro tape (hook type) x 2</p>	 <p>Velcro tape (loop type) x 3</p>
--	--	--	--

CONTENTS

	Page		Page
General Information		Advanced Features	
Precautions	1 - 2	Connecting other equipment	9
Controls and indicators	2 - 3	References	
Preparation for Use		Troubleshooting chart	9-10
Power Source	4	Maintenance	10
Remote control	4	Specifications	10
Basic Operation			
General control	5		
Bluetooth			
Bluetooth one touch connection via NFC	6		
Listening to Bluetooth enabled devices	7 - 8		

Precautions

■ General

- Please ensure that the equipment is positioned in a well ventilated area and ensure that there is a free space along the sides, top and back of the equipment as below.

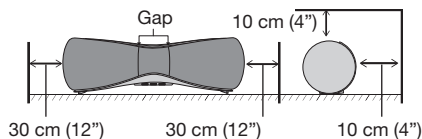

- Do not obstruct the gap when turning off the unit.
- Use the unit on a firm, level surface free from vibration.
- Place the unit at least 30 cm (12") away from any CRT TV to avoid colour variations across the TV screen. If the variations persist, move the unit further away from the TV. LED, plasma and LCD TV are not prone to such variation.
- Keep the unit away from direct sunlight, strong magnetic fields, excessive dust, humidity and electronic/electrical equipment (home computers, facsimiles, etc.) which generate electrical noise.
- Do not place anything on top of the unit.
- Do not expose the unit to moisture, to temperatures higher than 60°C (140°F) or to extremely low temperatures.

- If your system does not work properly, disconnect the AC power lead from the wall socket. Plug the AC power lead back in, and then turn on your system.
- In case of an electrical storm, unplug the unit for safety.
- Hold the AC power plug by the head when removing it from the wall socket, as pulling the lead can damage internal wires.
- The AC power plug is used as a disconnect device and shall always remain readily operable.
- **Do not remove the outer cover, as this may result in electric shock. Refer internal service to your local SHARP service facility.**
- The ventilation should not be impeded by covering the ventilation openings with items, such as newspapers, tablecloths, curtains, etc.
- No naked flame sources, such as lighted candles, should be placed on the apparatus.
- Attention should be drawn to the environmental aspects of battery disposal.
- This unit should only be used within the range of 5°C - 35°C (41°F - 95°F).
- The apparatus is designed for use in moderate climates.

Precautions (continued)

Warning:

The voltage used must be the same as that specified on this unit. Using this product with a higher voltage other than that which is specified is dangerous and may result in a fire or other type of accident causing damage. SHARP will not be held responsible for any damage resulting from use of this unit with a voltage other than that which is specified.

■ Volume control

The sound level at a given volume setting depends on speaker efficiency, location, and various other factors. It is advisable to avoid exposure to high volume levels. Do not turn the volume on to full at switch on. Listen to music at moderate levels.

Controls and indicators

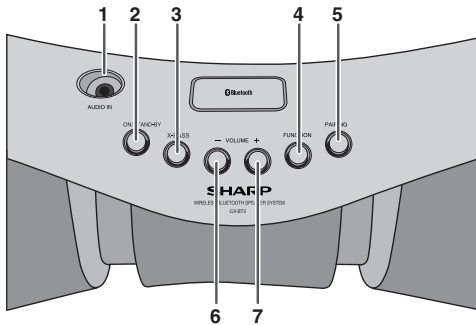

■ Front panel

	Page
1. Audio in socket	9
2. On/Stand-by Button	5, 7
3. X-Bass Button	5
4. Function Button	5
5. Pairing Button	7
6. Volume Down Button.....	5
7. Volume Up Button.....	5
8. LED light	5
9. Remote Sensor	4
10. Bluetooth/Pairing indicator	5, 7

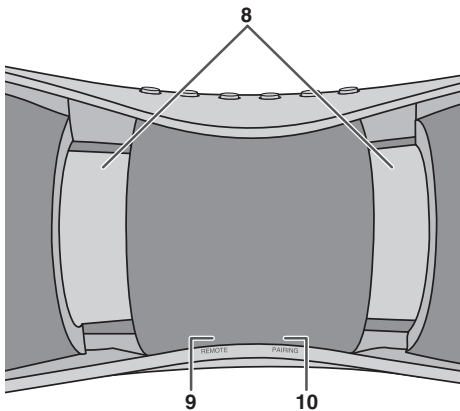

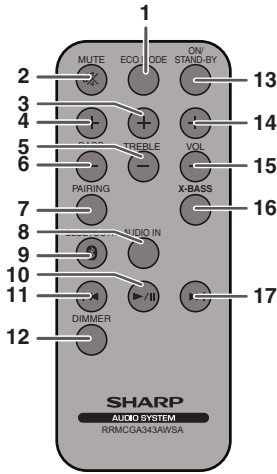

Remote control

	Page
1. Eco Mode Button	4
2. Mute Button	5
3. Treble + Button	5
4. Bass + Button	5
5. Treble - Button	5
6. Bass- Button	5
7. Pairing Button	7
8. Audio In Button	5
9. Bluetooth Button	7
10. Play/Pause Button	6
11. Skip down Button	6
12. Dimmer Button	5
13. On/Stand-by Button	5
14. Volume Up Button	5
15. Volume Down Button	5
16. X-Bass Button	5
17. Skip up Button	6

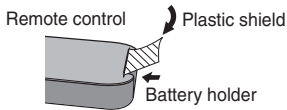

Note:

Before using the remote control, remove the plastic shield from the battery holder.

Speakers

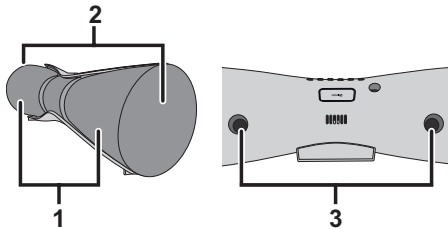

1. Front speaker
2. Subwoofer

3. Bass Reflex Duct

Power Source

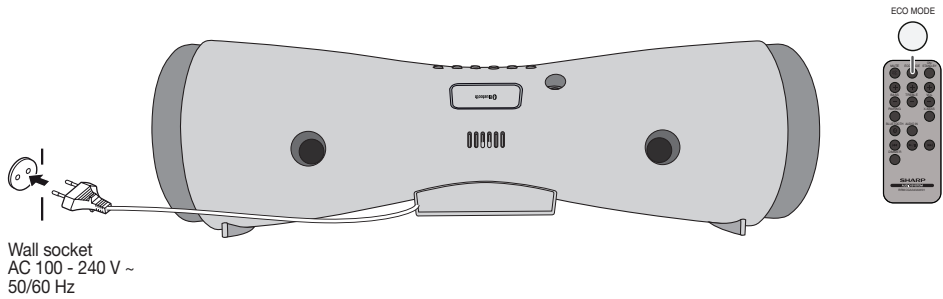

Wall socket
AC 100 - 240 V ~
50/60 Hz

■ AC power connection

Notes:

- Unplug the AC power lead from the wall socket if the unit will not be in use for a prolonged period of time.

■ Bluetooth stand-by mode

- The first time the unit is plugged in, the unit will enter the Bluetooth stand-by mode. Pairing indicator will light up.

- To cancel the Bluetooth stand-by mode, press the ECO MODE button (remote control) during Bluetooth stand-by mode. The unit will enter the low power consumption mode.
- To return to the Bluetooth stand-by mode, turn the unit on and off again.
- During Bluetooth stand-by mode, the unit will turn on if Bluetooth connection is established.

Remote control

■ Battery installation

- 1 Whilst pushing the locking tab towards the centre of the remote control, slide out the battery holder.



- 2 Remove the old battery from the battery holder, insert the new battery and then slide the battery holder back into the remote control.

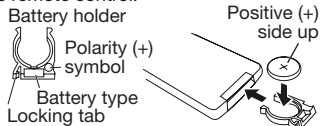

Precautions for battery use:

Remove the battery if the unit will not be used for a long period of time. This will prevent potential damage due to battery leakage.

Caution:

- Do not use rechargeable battery (nickel-cadmium battery, etc.).
- Danger of explosion if battery is incorrectly replaced.
- Replace only with the same or equivalent type.
- Batteries (battery pack or batteries installed) shall not be exposed to excessive heat such as sunshine, fire or the like.
- Installing the battery incorrectly may cause the unit to malfunction.

Notes concerning use:

- Replace the battery if the operating distance is reduced or if the operation becomes erratic. Purchase "CR 2025", coin lithium battery.
- Periodically clean the transmitter on the remote control with a soft cloth.
- Exposing the sensor on the unit to strong light may interfere with operation. Change the lighting or the direction of the unit if this occurs.
- Keep the remote control away from moisture, heat, shock, and vibrations.

■ Test of the remote control

The remote control can be used within the range shown below:

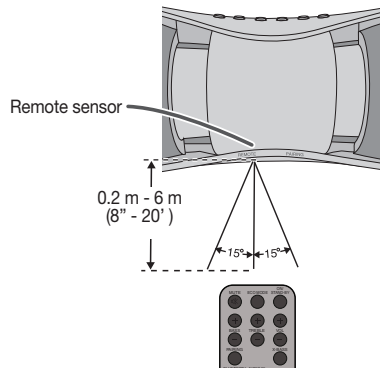

General control

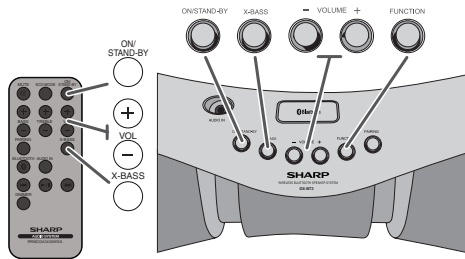

■ To turn the power on

Press the ON/STAND-BY button to turn the power on. When the power is first turned on, the speaker frames move outwards and pneumatic sound will be heard (default setting). To turn off the pneumatic sound, press and hold the X-BASS button. The LED lights up and then fades out. To return to the default setting, press and hold the X-BASS button again. The LED light will slowly fade in.

After use:

Press the ON/STAND-BY button to enter the power stand-by mode.

■ LED light brightness control

To dim the LED light brightness. Press DIMMER button on the remote control to change the mode.

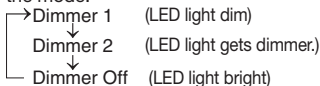

■ Volume auto fade-in

If you turn off and on the main unit with the volume set to almost maximum, the main unit starts with moderate volume and fades in to the last set level.

■ Volume control

Press VOLUME +/- buttons (on main unit) or VOL +/- (on remote control) to increase or decrease the volume. The LED light will blink when the volume reaches maximum or minimum level.

■ Function

When the FUNCTION button on the main unit is pressed, the current function will change. Press the FUNCTION button repeatedly to select the desired function.

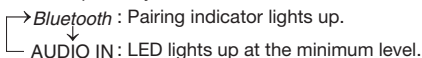

■ Direct key power on function

When you press any of the following buttons, the unit turns on.

- **▶/||** on the remote control: last selected function activated.
- **AUDIO IN** on the remote control: audio function activated.
- **BLUETOOTH** on the remote control: *Bluetooth* function activated

■ Auto power off function

The unit will enter the stand-by mode if:
Bluetooth: No connection for 60 seconds.
Audio In: No detection of input signal after 20 minutes

■ X-Bass control

To turn on/off the X-Bass, press the X-BASS button repeatedly until the desired X-Bass mode appears. LED will light up according to the desired X-Bass mode.

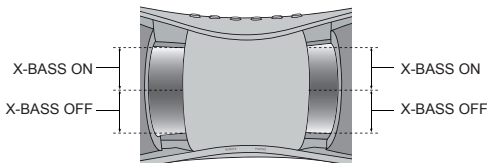

Note
 The X-Bass mode will be set to off when BASS/TREBLE control is adjusted.

■ Bass and treble control

Press BASS or TREBLE +/- button on the remote control to increase or decrease the bass or treble level respectively. LED will light up according to the desired Bass or Treble level.

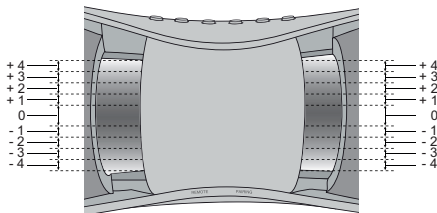

■ Muting

The volume is muted temporarily when pressing the MUTE button on the remote control. Press again to restore the volume.

Bluetooth one touch connection via NFC

About NFC technology

Near Field Communication (NFC) is a set of standards for devices (smartphones/tablets) to establish radio communication with each other by touching/tapping them together or bringing them into close proximity. Using NFC in this product simplifies the pairing method of *Bluetooth* connectivity.

- This audio system supports NFC-enabled device with Android 4.1, Jelly Bean and higher.
- For device with a lower Android version, refer the operation manual of the device for recommended app (application).

Unlike other wireless technology, **NFC requires no discovery or pairing.**

Simply tap the source device to the NFC tag to instantly enjoy seamless connectivity between your smart device and the audio system.

NFC detection area

NFC detection area location may vary depending on the device (smartphone/tablet). Refer operation manual of the device for detail.

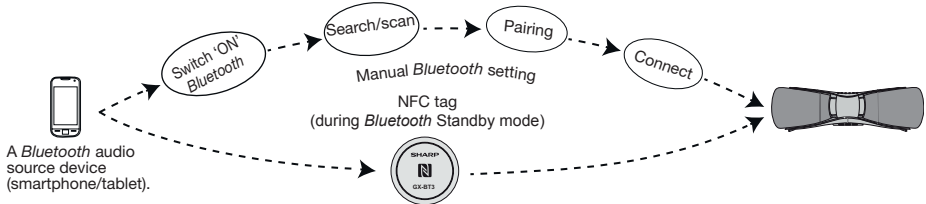

NFC tag set up

The NFC tags can be placed anywhere convenient to you. The velcro tapes supplied will help to secure the tags onto the desired location.

Caution:

- Make sure that the NFC tag is placed on a flat and level surface.
- **If you choose not to use the velcro tape, do not place the NFC tag near metal surface to avoid connection interference during tagging.**

Important:

- NFC tag has unique ID for each individual set, SHARP provides 2 identical tags for your convenience.
- SHARP will not be held liable for the damages caused by rewriting the tags.

Keep all small parts away from children as they may be accidentally swallowed.

- 1 Peel the separator off the velcro tape (loop type) and stick it on a desired surface.

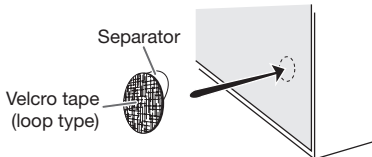

- 2 Peel the separator off the velcro tape (hook type) and stick it to the rear of the NFC tag. Then place the tag onto the desired location.

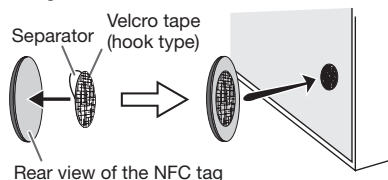

NFC connection for audio playback

Check that:

- Your device (smartphone/tablet) has an NFC function.
- NFC function on your device is enabled.
- Screen lock function of the device is off.
- This unit is not in Eco mode.
- Your device must be within 10 metres from the unit.

- 1 Touch your device to the supplied NFC tag.



- 2 A pop-up window asking whether to proceed with the Bluetooth connection appears on the device. Select <YES>.

- The 'connected' message appears when the connection is complete.

- 3 Playback will start automatically, otherwise press play (on remote control or source device).

- Sound will be heard from the speakers of this unit via audio streaming.
- Your device must be within 10 metres from the unit.

Various <i>Bluetooth</i> operation buttons (remote control only)	
	Press the button to play or pause.
	Press the button to skip up. Press and hold to fast forward.
	Press the button to skip down. Press and hold to fast reverse.

Notes:

- To disconnect, simply touch your device to the tag again.
- Regardless of which tag you used to establish *Bluetooth* connection with this product, tapping your device to any of the NFC tags again, will disconnect the *Bluetooth* connection.
- To listen to audio via *Bluetooth* connectivity without NFC tag - refer "**Pairing with other *Bluetooth* source devices**" on page 7.
- It takes about 6-8 seconds for a *Bluetooth* enabled device (eg. smartphone) to establish *Bluetooth* connection with this unit via NFC or manual connection.

Listening to *Bluetooth* enabled devices

Bluetooth

Bluetooth wireless technology is a short-range radio technology that enables wireless communication between various types of digital devices, such as mobile phone or computer. It operates within a range of about 10 metres (30 feet) without the hassle of having to use cables to connect these devices.

This unit supports the following:

Communication System: *Bluetooth* Specification version 2.1 *Bluetooth* + Enhanced Data Rate (EDR).

Support Profile : A2DP (Advanced Audio Distribution Profile) and AVRCP (Audio/Video Remote Control Profile)

Notes when using unit with a mobile phone

- This unit cannot be used to talk over the telephone even when there is a *Bluetooth* connection made to a mobile phone.
- Please refer to the operating manual supplied with the mobile phone for details on operation of your mobile phone whilst transmitting the sound using a *Bluetooth* connection.

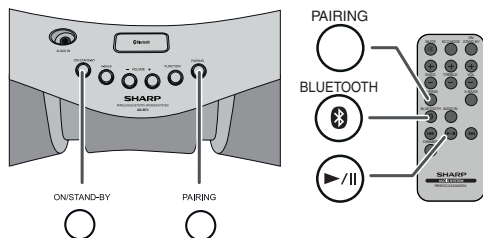

Pairing *Bluetooth* devices

Bluetooth devices need to be initially paired first before they can exchange data. Once paired, it is not necessary to pair them again unless:

- pairing is made with more than 8 devices. Pairing can only be made one device at a time. This unit can be paired to a maximum of 8 devices. If subsequent device is paired, the oldest device paired, will be deleted and replaced with the new one.
- this unit is reset. All pairing information is deleted when unit is reset.
- pairing information is deleted whilst re-pairing, etc.

Indicators:

Status	PAIRING indicator (blue)
Unconnected	Blinks
Pairing mode	Blinks quickly
Connected	Lights up

However, the indicator status is not displayed during *Bluetooth* stand-by mode.

Pairing with other *Bluetooth* source devices

- 1 Press the ON/STAND-BY button to turn the power on.
- 2 Press the *BLUETOOTH* button on the remote control or FUNCTION button repeatedly on the main unit to select *Bluetooth* function. (Pairing indicator blinks.)
- 3 Press and hold the PAIRING button for 3 seconds or more. PAIRING indicator blinks quickly. The unit is now in pairing mode and is ready to be paired with other *Bluetooth* source device.
- 4 Perform pairing procedure on the source device to detect this unit. "SHARP GX-BT3" will appear in the detected devices list (if available) in the source device. (Refer the source device operating manual for details).

Notes:

- Place the devices to be paired within 1 metre (3 feet) of each other when pairing.
 - Some source devices are unable to display lists of detected devices. To pair this unit with the source device, refer to the source device operating manual for details.
- 5 Select "SHARP GX-BT3" from the source list. If Passcode* is required, enter "0000".
* Passcode may be called PIN Code, Passkey, PIN number or Password.
 - 6 Pairing indicator (blue) will stop blinking once the unit is successfully paired with the source device. (Pairing information is now memorised in the unit.) Some audio source devices may connect with the unit automatically after pairing is completed, otherwise follow the instructions in the source device operating manual to start connection.
 - 7 Press the play button on remote control or source device to start *Bluetooth* streaming playback.

Notes:

- If a device such as microwave oven, wireless LAN card, *Bluetooth* device or any other device that uses the same 2.4 GHz frequency near the system some sound interruption may be heard.
- The transmission distance of the wireless signal between the device and the main unit is about 10 m (30 feet), but may vary depending on your operating environment. If a steel concrete or metallic wall is between the device and the main unit, the system may not operate at all, because the wireless signal cannot penetrate metal.
- If this unit or the source device is turned off before *Bluetooth* connection is completed, pairing will not be completed and the pairing information will not be memorised. Repeat step 1 onwards to start pairing again.
- To pair with other devices, repeat steps 1 - 5 for each device. This unit can be paired to a maximum of 8 devices. If subsequent device is paired, the oldest device paired, will be deleted and replaced with the new one.
- Once a device is ousted or deleted from the pairing list, the pairing information for the device is also deleted. To listen to the sound from the device again, it needs to be re-paired. Perform steps 1 - 5 to pair the device again.

Listening to *Bluetooth* enabled devices (continued)

■ Listening to the sound

Check that:

- The source device *Bluetooth* functionality is ON.
- Pairing of this unit and the source device is completed.
- Unit is in connected mode (pairing indicator (BLUE) lights up.)

- 1 Press the ON/STAND-BY button to turn the power on.
- 2 Press the *BLUETOOTH* button on the remote control or FUNCTION button repeatedly on the main unit to select *Bluetooth* function.
- 3 Start the *Bluetooth* connection from the *Bluetooth* stereo audio source device.
- 4 Playback will start automatically, otherwise press play (on remote control or source device).

Notes:

- For various *Bluetooth* operations, refer “NFC connection for audio playback” on page 6.
- If the source device has an extra bass function or equalizer function, set them to off. If these functions are on, sound may be distorted.

Notes:

- Make the *Bluetooth* connection again if the source device is not turned on, or its *Bluetooth* functionality is off or is in sleep mode.

■ To disconnect the *Bluetooth* device

Perform any of the followings.

- Disconnect the *Bluetooth* connection on the audio source device.
Refer the operating manual supplied with the device.
- Turn off the *Bluetooth* stereo audio source device.
- Turn off this unit.

Note:

The volume of this unit may not be controlled as intended depending on the device.

■ Auto power on

During *Bluetooth* stand-by mode, the unit will automatically power on when the *Bluetooth* connection has been set up between the main unit and your device.

Note:

This function is not applicable during Eco mode.

Connecting other equipment

■ Listening to the playback sounds of portable audio player, etc.

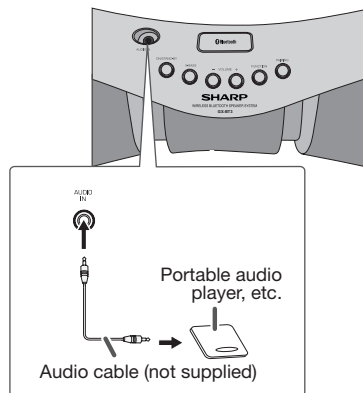

- 1 Use a connection lead to plug in the portable audio player, etc. to the AUDIO IN socket. When using video equipment, plug in the audio output to this unit and the video output to a television.
- 2 Press the ON/STAND-BY button to turn the power on.
- 3 Press the AUDIO IN button on the remote control or FUNCTION button repeatedly on the main unit to select AUDIO IN function.
- 4 Play the connected equipment. If volume level of the connected device is too high, sound distortion may occur. Should this happen, lower the volume of the connected device. If volume level is too low, increase the volume of the connected device.

Note:

To prevent noise interference, place the unit away from the television.

Troubleshooting chart

Many potential problems can be resolved by the owner without calling a service technician.

If something is wrong with this product, check the following before calling your authorised SHARP dealer or service centre.

■ General

Symptom	Possible cause
● When a button is pressed, the unit does not respond.	<ul style="list-style-type: none"> ● Set the unit to the power stand-by mode and then turn it back on. ● If the unit still malfunctions, reset it. (Refer page 10)
● No sound is heard.	<ul style="list-style-type: none"> ● The volume level is set to minimum.

■ Remote control

Symptom	Possible cause
● The remote control does not operate.	<ul style="list-style-type: none"> ● The AC power lead of the unit is not plugged in. ● The batteries are exhausted. ● The distance or angle is incorrect. ● The remote control sensor receives strong light.

■ NFC / Bluetooth

Symptom	Possible cause
● No sound is heard.	<ul style="list-style-type: none"> ● The unit is too far from the <i>Bluetooth</i> stereo audio source device. ● The unit is not paired with the <i>Bluetooth</i> stereo audio source device.
● <i>Bluetooth</i> sound is interrupted or distorted.	<ul style="list-style-type: none"> ● The unit is too near to a device that generates electromagnetic radiation. ● There is an obstacle between the unit and the <i>Bluetooth</i> stereo audio source device.
● NFC-enabled device cannot connect to <i>Bluetooth</i> via NFC tag.	<ul style="list-style-type: none"> ● Main unit is not in <i>Bluetooth</i> pairing mode. Perform "NFC connection for audio playback". (Refer page 6.)

■ Condensation

Sudden temperature changes, storage or operation in an extremely humid environment may cause condensation inside the cabinet or on the transmitter on the remote control. Condensation can cause the unit to malfunction. If this happens, leave the power on until normal playback is possible (about 1 hour). Wipe off any condensation on the transmitter with a soft cloth before operating the unit.

Troubleshooting chart (continued)

■ If problem occurs

When this product is subjected to strong external interference (mechanical shock, excessive static electricity, abnormal supply voltage due to lightning, etc.) or if it is operated incorrectly, it may malfunction.

If such a problem occurs, do the following:

- 1 Set the unit to the stand-by mode and turn the power on again.
- 2 If the unit is not restored in the previous operation, unplug and plug in the unit again, and then turn the power on.

Note:

If neither operation above restores the unit, clear all the memory by resetting it.

■ Factory reset, clearing all memory

- 1 Press the AUDIO IN (remote control) or FUNCTION button repeatedly (main unit) to select AUDIO IN function.
- 2 Press ►/|| button.
- 3 Within 1 second, press and hold ◀◀ button until PAIRING indicator lights up.



Caution:

This operation will restore the unit to factory default condition.

Specifications

As part of our policy of continuous improvement, SHARP reserves the right to make design and specification changes for product improvement without prior notice. The performance specification figures indicated are nominal values of production units. There may be some deviations from these values in individual units.

■ General

Power source	AC 100 - 240 V ~ 50/60 Hz
Power consumption	AC: Power on: 5 W Power stand-by: 0.4 W (*)
Dimensions	Width: 446 mm (17 - 9/16") Height: 155 mm (6 - 1/8") Depth: 154 mm (6 - 1/16")
Weight	2.5 kg (5.5 lbs.)
Frequency band	2.400 GHz - 2.480 GHz
Compatible Bluetooth Profile	A2DP (Advanced Audio Distribution Profile), AVRCP (Audio/Video Remote Control Profile) Bluetooth 2.1 +EDR

(*) This power consumption value is obtained when the Bluetooth stand-by mode is cancelled in the power stand-by mode. Refer to page 4 to cancel the Bluetooth stand-by mode.

■ Before transporting the unit

Caution:

Remove all devices plugged in to the unit. Then, set the unit to the power stand-by mode. Transporting the unit with other devices plugged in might damage the units.

Maintenance

■ Cleaning the cabinet

Periodically wipe the cabinet with a soft cloth and a diluted soap solution, then with a dry cloth.

Caution:

- Do not use chemicals for cleaning (petrol, paint thinner, etc.). It may damage the cabinet.
- Do not apply oil to the inside of the unit. It may cause malfunctions.

■ Amplifier

Output power	Front speaker: RMS: 10 W (5 W + 5 W) (10% T.H.D.) RMS: 7 W (3.5 W + 3.5 W) (1% T.H.D.) Subwoofer: RMS: 10 W (10% T.H.D.) RMS: 8 W (1% T.H.D.)
Input terminals	Audio In (audio signal): 500 mV/47 k ohms

■ Speaker

Type	2-way type speaker system Front Speakers: 5 cm (2") - 3 Ω - Full Range Subwoofer: 8 cm (3-1/8") - 6 Ω - woofer
Maximum input power	Front Speakers: 10 W / Channel Subwoofer: 10 W / Channel
Rated input power	Front Speakers: 5 W / Channel Subwoofer: 5 W / Channel